

LCM Specification

Preliminary specification

Final Specification

Project No. 项目编号	TFT-H024A9QVIFT5R20		
Customer 客户名称			
Module No. 客户型号			
Product type 产品内容	TFT LCD Module 240 x 3RGB x 320 Dots 2.4" TFT LCD		
Signature by customer: 客户确认签章:			
<input type="checkbox"/> Trial production		<input type="checkbox"/> Mass production	
编 制	电子审核	结构审核	批 准
Y. L			

深圳市鑫洪泰电子科技有限公司

Shenzhen Hot Display Technology Co., Ltd

1 Document revision history :

DOCUMENT REVISION	DATE	DESCRIPTION	PREPARED BY	APPROVED BY
0	2020-04-17	First Release.	Y.L	

1. General Feature:

Item	Standard Value	Unit
Display Size	2.4"	--
Number of Pixels	240(H)x3(RGB)*320(V)	--
Active Area	36.72(H) *48.96(V)	mm
Outline Dimension	42.52(H) ×59.86(V)× 3.40(D) <TFT+RTP>	mm
Viewing Direction	Full O'Clock	-
Interface	MIPI-1L (Video mode)	-
Driver IC	JD9852	-
Driver Condition	VCI=2.8V, IOVCC=1.8V	V
Backlight	White LED	-
Touch Panel	Resistive Touch Panel	-
CTP Driver IC	---	
CTP Driver Condition	VDD=3.3V	
Operation Temperature	-20~70	°C
Storage Temperature	-30~80	°C

2.Outline Dimensions

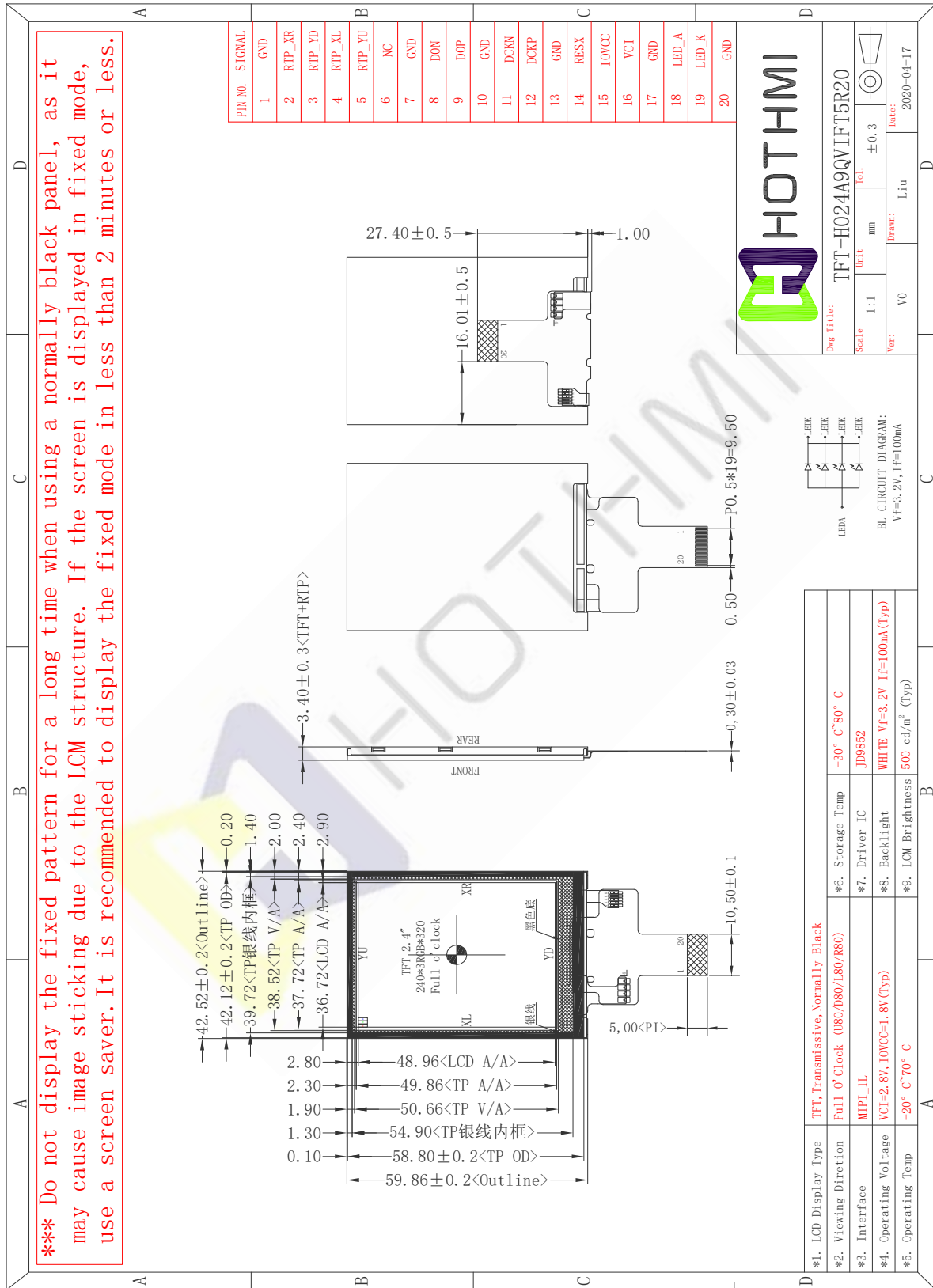

3. Pin Description

3.1 Pin Description

Pin NO.	Symbol	Description
1	GND	Ground
2	RTP_XR	Resistive touch control signal
3	RTP_YD	Resistive touch control signal
4	RTP_XL	Resistive touch control signal
5	RTP_YU	Resistive touch control signal
6	NC	No Connect
7	GND	Ground
8	D0N	MIPI-DSI Data differential signal input pins.
9	D0P	MIPI-DSI Data differential signal input pins.
10	GND	Ground
11	DCKN	MIPI-DSI CLOCK differential signal input pins.
12	DCKP	MIPI-DSI CLOCK differential signal input pins.
13	GND	Ground
14	RESX	Global reset pin. Active low to enter reset state.
15	IOVCC	Logic Power(1.75 ~ 3.3 V,1.8V Type)
16	VCI	Analog Power(2.6 ~ 3.3 V,2.8V Type)
17	GND	Ground
18	LED_A	LED Anode
19	LED_K	LED Cathode
20	GND	Ground

---END---

3.2 Wiring Diagram

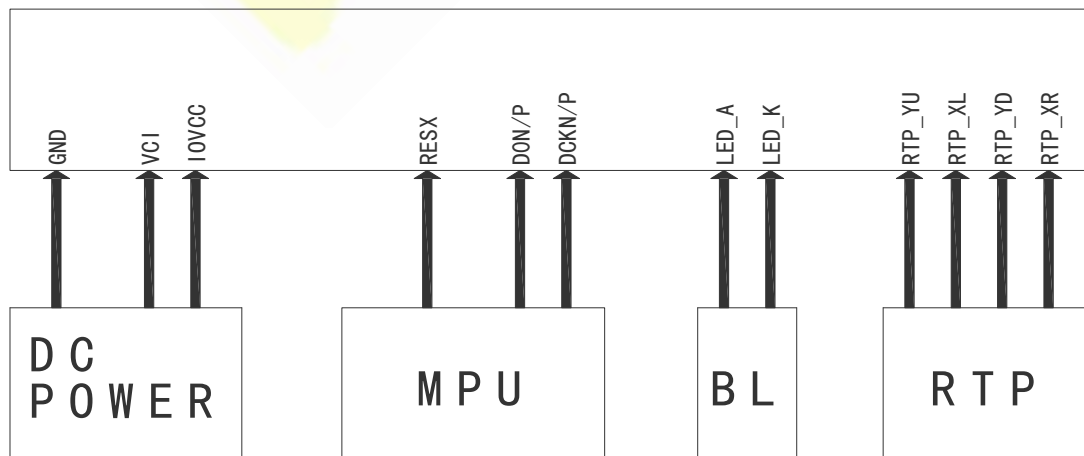

4. Electrical Characteristics

4-1 TFT LCD Module Operating Conditions

Item	Symbol	Condition	Min	Type	Max	Unit
Interface logic circuits	IOVCC	-	1.75	1.8	3.3	V
Analog Power supply	VCI	-	2.6	2.8	3.3	V
TFT Gate on voltage	VGH	-	10.0	-	16.0	V
TFT Gate off voltage	VGL	-	-16.0	-	-10.0	V

4-2 LED back light specification (pera chip)

Item	Symbol	Condition	Min	Type	Max	Unit
Forward voltage	Vt	If=20mA	2.8	3.2	3.4	V
Forward current	Ipn	/1-chip	-	100	-	mA
Luminance(With LCD)	Lv	If=100mA	-	500	-	cd/m ²
Luminous color	White					

4-3 CTP Operating Conditions

Item	Symbol	Condition	Min	Type	Max	Unit
Power Supply Voltages	VDD	-	2.8	3.30	3.60	V
I/O Digital Voltage	IOVDD	-	2.8	3.30	3.60	V

5. OPTICAL SPECIFICATION

5.1 Overview

The test of Optical specifications shall be measured in a dark room (ambient luminance 1lux and temperature = 25 ± 2°C) with the equipment of Luminance meter system (Goniometer system and TOPCON BM-5) and test unit shall be located at an approximate distance 50cm from the LCD surface at a viewing angle of θ and Φ equal to 0°. The center of the measuring spot on the Display surface shall stay fixed. The backlight should be operating for 30 minutes prior to measurement.

5.2 Optical Specifications

Parameter		Symbol	Condition	Min.	Typ.	Max.	Unit	Remark
Viewing Angle Range	Horizontal	Θ L	CR>10	-	80	-	Deg.	Note 1
		Θ R		-	80	-	Deg.	
	Vertical	Θ U		-	80	-	Deg.	
		Θ D		-	80	-	Deg.	
Contrast ratio		CR	$\Theta = 0^\circ$	1000	1500	-		Note2
Color Gamut		CG		65	70	-	%	
White Chromaticity		Wx			0.307			
		Wy			0.334			
Reproduction of color	Red	Rx	$\Theta = 0^\circ$	-0.02	0.652	+0.02		Note4 (Based on C Light)
		Ry			0.322			
	Green	Gx			0.276			
		Gy			0.582			
	Blue	Bx			0.141			
		By			0.091			
Response Time (Rising + Falling)		Tr+Tf	$\Theta = 0^\circ$ Ta= 25°C	-	35	45	ms	Note5
Transmittance(with Polarizer)		Tr		-	4.65	-	%	Note3

Note:

1.Viewing angle is the angle at which the contrast ratio is greater than 10. The viewing angles are determined for the horizontal or 3, 9 o' clock direction and the vertical or 6, 12 o' clock direction with respect to the optical axis which is normal to the LCD surface (see FIGURE 1).

2.Contrast measurements shall be made at viewing angle of $\Theta = 0$ and at the center of the LCD surface. Luminance shall be measured with all pixels in the view field set first to white, then to the dark (black)

state . (see FIGUR 1) Luminance Contrast Ratio (CR) is defined mathematically.

$$CR = \frac{\text{Luminance when displaying a white raster}}{\text{Luminance when displaying a black raster}}$$

3. Transmittance is the Value without APF and without CG.

4. The color chromaticity coordinates specified in the above table shall be calculated from the spectral data measured with all pixels first in red, green, blue and white. Measurements shall be made at the center of the panel.

5. The electro-optical response time measurements shall be made as FIGURE 2 by switching the “data” input signal ON and OFF. The times needed for the luminance to change from 10% to 90% is T_r , and 90% to 10% is T_f .

Figure1 Measurement Set Up

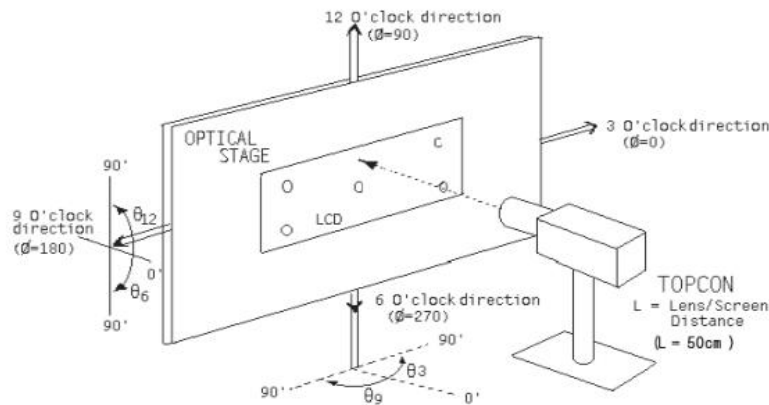
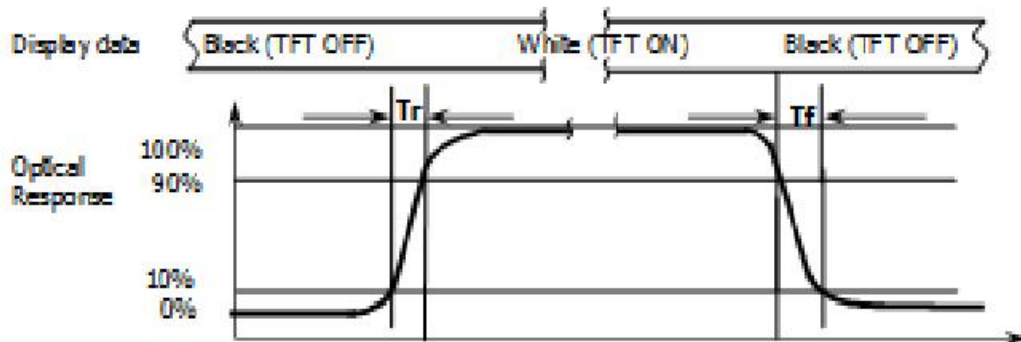
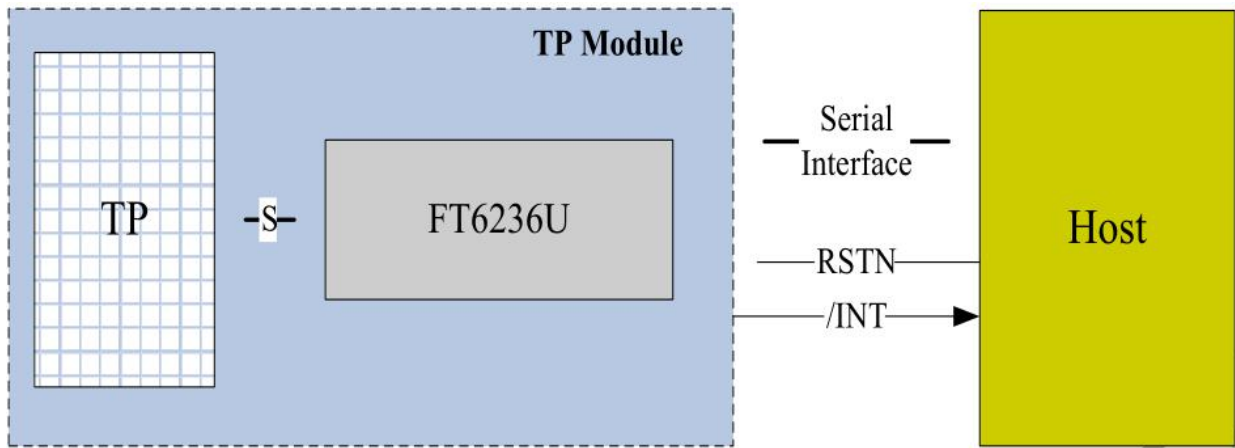

Figure2 Response Time Testing



6-2 CTP Timing Characteristics

6-2-1 Host Interface Diagram



6-2-2 I2C Timing

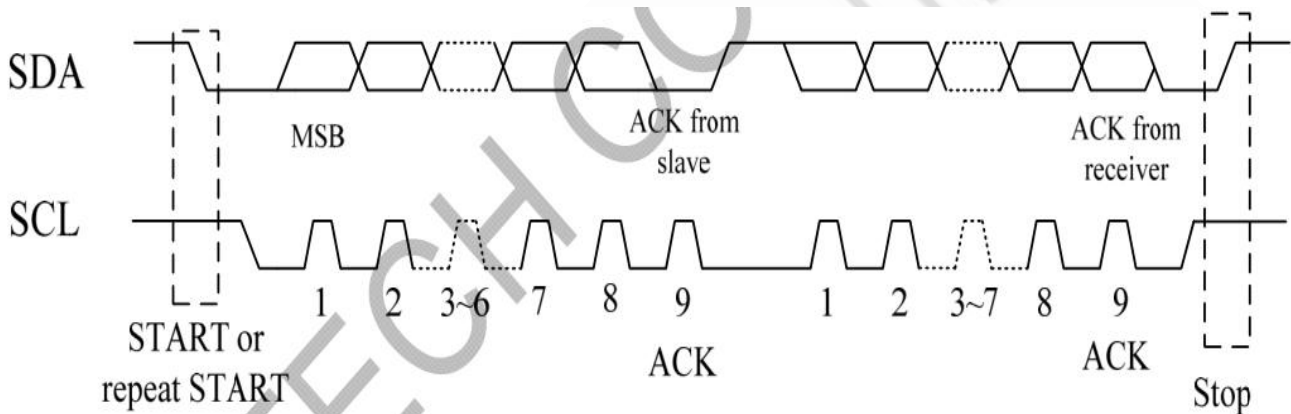

Parameter	Min	Max	Unit
SCL frequency	10	400	KHz
Bus free time between a STOP and START condition	4.7	\	us
Hold time (repeated) START condition	4.0	\	us
Data setup time	250	\	ns
Setup time for a repeated START condition	4.7	\	us
Setup Time for STOP condition	4.0	\	us

7. RELIABILITY TEST

7-1 Temperature and Humidity

TEST ITEMS	CONDITIONS	NOTE
High Temperature Storage	Ta=+80 o C, 240hrs	
Low Temperature Storage	Ta=-30 o C, 240hrs	
High Temperature Operation	Ta=+70 o C, 240hrs	
Low Temperature Operation	Ta=-20 o C, 240hrs	
High Temperature and High Humidity (Operating)	Ta=+60 o C, 90%RH, 240hrs	

Note: (1) All tests above are practiced at module type.

(2) There is no display function NG issue occurred, all the cosmetic specification is judged before the reliability stress.

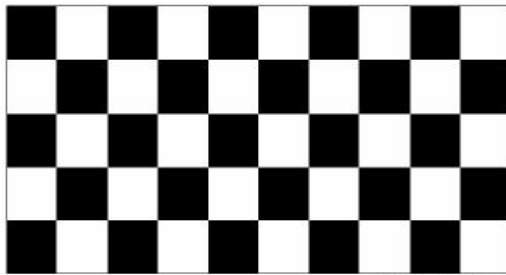

(a) Test Pattern (chess board Pattern)



(b) Gray Pattern

7-2 Shock and Vibration

ITEMS	CONDITIONS
Packing Shock (Non-Operation)	<ul style="list-style-type: none"> ● Shock level:980m/s² ● Waveform:1/2 Sine wave,6msec ● ±X, ±Y ±Z,each axis 1 times
Packing Vibration (Non-Operation)	<ul style="list-style-type: none"> ● Frequency range:8-33.3HZ ● Stoke:1.0mm ● Sweep: 10Hz-50Hz ● x,y,z 2 hours for each direction

7-3 Electrostatic Discharge

TEST ITEM	CONDITIONS
ESD (Non-operation)	150pF,330 Ω , Contact±4KV,Air :±8KV.Note 1
	200pF,0 Ω , ±200V Contact test.Note 2

Note:Measure Point:

- 1.LCD glass and metal bezel
- 2.IF connector pins

8. HANDLING & CAUTIONS

8-1 Caution For Operation

◆ Since the LCM is made of glass, do not apply strong mechanical impact or static load onto it. Handling with care since shock, vibration, and careless handling may seriously affect the product. If it falls from a high place or receives a strong shock, the glass may be broken.

◆ It is indispensable to drive the LCM within the specified voltage limit since the higher voltage than the limit causes LCM's life shorter. An electro-chemical reaction due to DC causes undesirable deterioration of the LCM so that the use of DC drive should be avoided.

◆ Do not connect or disconnect the LCM to or from the system when power is on.

◆ Never use the LCM under abnormal conditions of high temperature and high humidity.

◆ When exposed to drastic fluctuation of temperature (hot to cold or cold to hot), the LCM may be affected; specifically, drastic temperature fluctuation from cold to hot, produces dew on the LCM's surface which may affect the operation of the polarizer on the LCM.

◆ Response time will be extremely delayed at lower temperature than the operating temperature range and on the other hand LCM may turn black at temperature above its operational range. However those phenomena do not mean malfunction or out of order with the LCM. The LCM will revert to normal operation once the temperature returns to the recommended temperature range for normal operation.

◆ Do not display the fixed pattern for a long time when using a normally black panel, as it may cause image sticking due to the LCM structure. If the screen is displayed in fixed mode, use a screen saver. It is recommended to display the fixed mode in less than 2 minutes or less.

◆ Do not disassemble and/or re-assemble LCM module

8-2 Caution Against Static Charge

◆ The LCM uses C-MOS LSI drivers, so customers are recommended that any unused input terminal would be connected to V_{DD} or V_{SS}, do not input any signals before power is turned on, and ground your body, work/assembly area, assembly equipments to protect against static electricity.

◆ Remove the protective film slowly, keeping the removing direction approximate 30-degree not vertical from panel surface, if possible, under ESD control device like ion blower, and the humidity of working room should be kept over 50%RH to reduce the risk of static charge.

◆ Avoid the use of work clothing made of synthetic fibers. We recommend cotton clothing or other conductivity-treated fibers.

◆ In handling the LCM, wear non-charged material gloves. And the conducting wrist to the earth and the conducting shoes to the earth are necessary

9. LCD display initialization code

Void Panel_Initial_code(void)

```
{
//Resolution: 240x320
//External system porch setting: VS=2 ,VBP=6 ,VFP=8 ,HS=4 ,HBP=20 ,HFP=40
//Frame rate:60HZ
//MIPI CLK:55.8MHZ
//Power:VCI=2.8,IOVCC=1.8
//Compare ID Register:page0 R04H=[0x98,0x52]

//PASSWORD
SSD_Number(0x04);
SSD_CMD(0xDF); //Password
SSD_PAR(0x98);
SSD_PAR(0x51);
SSD_PAR(0xE9);
//----- PAGE0 -----
SSD_Number(0x02);
SSD_CMD(0xDE);
SSD_PAR(0x00);

//VGMP,VGSP,VGMN,VGSN 4.4
SSD_Number(0x05);
SSD_CMD(0xB7);
SSD_PAR(0x16);//1E
SSD_PAR(0x7D);//81
SSD_PAR(0x16);//1E
SSD_PAR(0x3B);//2F

//Set_R_GAMMA
SSD_Number(0x21);
SSD_CMD(0xC8);
SSD_PAR(0x3F);
SSD_PAR(0x2B);
SSD_PAR(0x22);
SSD_PAR(0x21);
SSD_PAR(0x23);
SSD_PAR(0x26);
SSD_PAR(0x21);
```

```
SSD_PAR(0x22);  
SSD_PAR(0x22);  
SSD_PAR(0x22);  
SSD_PAR(0x1E);  
SSD_PAR(0x15);  
SSD_PAR(0x11);  
SSD_PAR(0x0A);  
SSD_PAR(0x09);  
SSD_PAR(0x0E);  
SSD_PAR(0x3F);  
SSD_PAR(0x2B);  
SSD_PAR(0x22);  
SSD_PAR(0x21);  
SSD_PAR(0x24);  
SSD_PAR(0x27);  
SSD_PAR(0x22);  
SSD_PAR(0x22);  
SSD_PAR(0x22);  
SSD_PAR(0x21);  
SSD_PAR(0x1E);  
SSD_PAR(0x14);  
SSD_PAR(0x11);  
SSD_PAR(0x0A);  
SSD_PAR(0x09);  
SSD_PAR(0x0E);
```

```
//POW_CTRL
```

```
SSD_Number(0x04);  
SSD_CMD(0xB9);  
SSD_PAR(0x33);  
SSD_PAR(0x08);  
SSD_PAR(0xCC);
```

```
//DCDC_SEL
```

```
SSD_Number(0x09);  
SSD_CMD(0xBB);  
SSD_PAR(0x47); //VGH 14.75,VGL-10  
SSD_PAR(0x7A);  
SSD_PAR(0x30);  
SSD_PAR(0x40); //3
```

```
SSD_PAR(0x7C); //6  
SSD_PAR(0x60);  
SSD_PAR(0x70); //50  
SSD_PAR(0x70);
```

```
//VDDD_CTRL  
SSD_Number(0x03);  
SSD_CMD(0xBC);  
SSD_PAR(0x38);  
SSD_PAR(0x3C);
```

```
//SETSTBA  
SSD_Number(0x02);  
SSD_CMD(0xC0);  
SSD_PAR(0x31);  
SSD_PAR(0x20);
```

```
//SETPANEL(default)  
SSD_Number(0x02);  
SSD_CMD(0xC1);  
SSD_PAR(0x12);
```

```
//SETRGBCYC  
SSD_Number(0x0A);  
SSD_CMD(0xC3);  
SSD_PAR(0x08);  
SSD_PAR(0x00);  
SSD_PAR(0x0A);  
SSD_PAR(0x10);  
SSD_PAR(0x08);  
SSD_PAR(0x54);  
SSD_PAR(0x45);  
SSD_PAR(0x71);  
SSD_PAR(0x2C);
```

```
//SETRGBCYC(default)  
SSD_Number(0x12);  
SSD_CMD(0xC4);  
SSD_PAR(0x00);  
SSD_PAR(0xA0);
```

```
SSD_PAR(0x79);
SSD_PAR(0x0E);
SSD_PAR(0x0A);
SSD_PAR(0x16);
SSD_PAR(0x79);
SSD_PAR(0x0E);
SSD_PAR(0x0A);
SSD_PAR(0x16);
SSD_PAR(0x79);
SSD_PAR(0x0E);
SSD_PAR(0x0A);
SSD_PAR(0x16);
SSD_PAR(0x82);
SSD_PAR(0x00);
SSD_PAR(0x03);

//SET_GD(default)
SSD_Number(0x07);
SSD_CMD(0xD0);
SSD_PAR(0x04);
SSD_PAR(0x0C);
SSD_PAR(0x6A);
SSD_PAR(0x0F);
SSD_PAR(0x00);
SSD_PAR(0x03);

//RAMCTRL(default)
SSD_Number(0x03);
SSD_CMD(0xD7);
SSD_PAR(0x13);
SSD_PAR(0x00);

//----- PAGE2 -----
SSD_Number(0x02);
SSD_CMD(0xDE);
SSD_PAR(0x02);
Delaysms(1);

//DCDC_SET
SSD_Number(0x06);
```



```
SSD_CMD(0xB8);  
SSD_PAR(0x1D);  
SSD_PAR(0xA0);  
SSD_PAR(0x2F);  
SSD_PAR(0x2C);  
SSD_PAR(0x2B);
```

```
//SETRGBCYC2  
SSD_Number(0x05);  
SSD_CMD(0xC1);  
SSD_PAR(0x10);  
SSD_PAR(0x66);  
SSD_PAR(0x66);  
SSD_PAR(0x01);
```

```
//----- PAGE0 -----  
SSD_Number(0x02);  
SSD_CMD(0xDE);  
SSD_PAR(0x00);
```

```
// sleep out  
SSD_Number(0x01);  
SSD_CMD(0x11); // SLPOUT  
Delaysms(120);
```

```
// display on  
SSD_Number(0x01);  
SSD_CMD(0x29); // SLPOUT  
}
```

--END--